

SPECIFICATION SHEET

UT-18B

Recessed electronic infrared flushing control for urinal with a vandal proof complete stainless steel plate in satin finish. Solid brass valve with built-in flow control valve and strainer fitted within the outer stainless steel box.

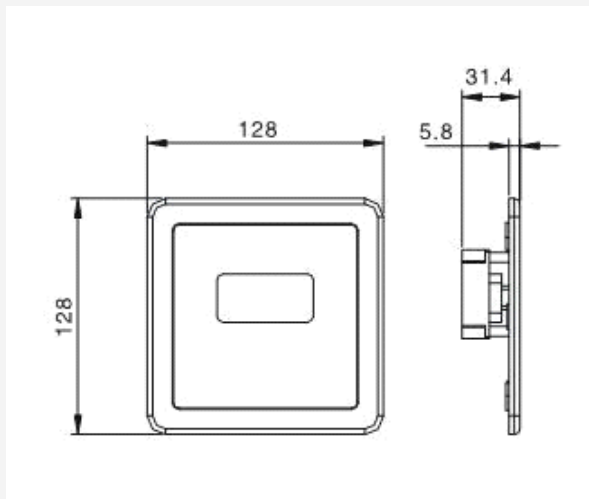

Model No.	UT-18B	UT-18C	UT-18B+C
	Battery Operated	Electrically Operated	Electrical Operated with Battery Backup
External Material	Screwless s/s plate	Screwless s/s plate	Screwless s/s plate
Dimensions	128 X 128 mm	128 X 128 mm	128 X 128 mm
Power	4 "AA" Alkaline Batteries	AC220V/50Hz	4 "AA" Alkaline Batteries + AC220V/50Hz
Battery life	2 year's with 100 operations /day	(Optional) Battery standby	2 year's with 100 operations /day
Water pressure	0.4-8 bar	0.4-8 bar	0.4-8 bar
Detection range	Automatic	Automatic	Automatic
Flushing time	6 s	6 s	6 s
Plumbing Connections	G 1/2"	G 1/2"	G 1/2"
Ambient temperature	1~55°C	1~55°C	1~55°C
Power consumption in satic	= 0.5 mW (DC), =3W(AC)	= 0.5 mW (DC), =3W(AC)	= 0.5 mW (DC), =3W(AC)