

SPECIFICATION SHEET

UT-25BC

Touch-free infrared based electronic tap. The tap is activated automatically when the users place their hands within the sensor range and stops when the users remove their hands. Made with solid brass and chrome plated. Helps washrooms to stay clean and saves water. Touch free usage prevents cross contamination.

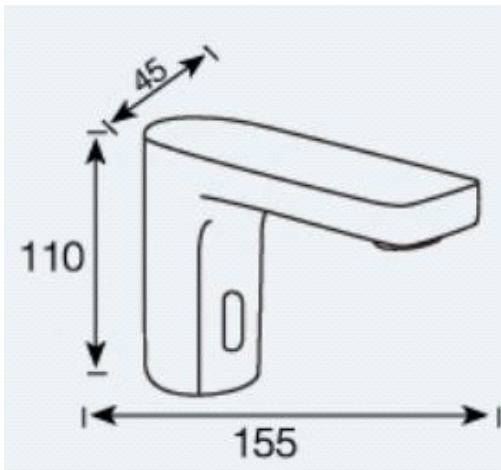

Model No.	UT-25BC
Power	DC6V / AC220V / Dual
Average static power consumption	<50uA
Instant dynamic power consumption	<2.5W
Working water pressure	0.05-0.7MPa
Sensor distance	10-30cm
Error detection time	<0.6 second
Maximum washing time	60 seconds (Default)
Inlet diameter	G1/2"
Outlet diameter	G1/2"